



Legacy Special Tool List 914, 2011 & 2012



Blue denotes Competency Class Level II special tooling.

Gold denotes Competency Class Level III only tools.

- I 914
- II 2011
- III 2012
- IV 2011 & 2012
- V 914, 2011 & 2012

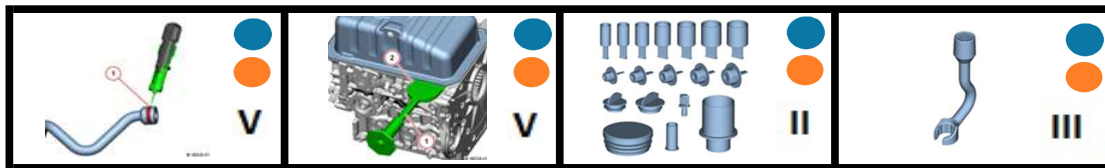

2992127	2992301	1899368	2992477
Disassembly Tool	Separating Tool	Locking Plugs / Caps	Special Wrench (Fuel Line)



1899092	2992294	1899103	1899110
Hexalobular Tool Kit	Slide Hammer	Pick	Assembly Lever



1899034	1899193	1899415	1899112
Compression Gauge (With Adapter)	Compression Chart Sheets	Cooling System Pressure Tester	Spring Band Pliers

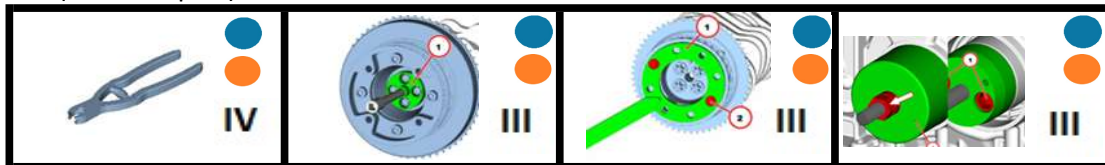

1899037	2992028	2992275	2992223
Hose clip pliers (Cobra Clamps)	Turning Gear	Pulley Holder	Crank Seal Ring Ass (Flywheel End)



Legacy Special Tool List 914, 2011 & 2012



2992213	2992311	1899050	1899093
Crank Seal Ring Ass (Opposite Flywheel)	Cooling Fan Shaft Seal Installer	Assembly Pliers	Torque Angle Disc

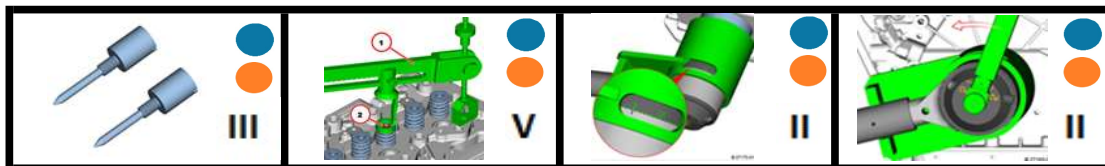

2992046	2992143	1899055	1899370
Guide Pins (Mass Bal. Shafts)	Valve Spring Compressor	Socket Wrench Insert 32MM	Force Multiplier



2992017	2992214	2992215	2992483
Compression Gauge Connector	Assembly Tool (Flywheel Side)	Assembly Tool (Crank Seal)	Counter Holder





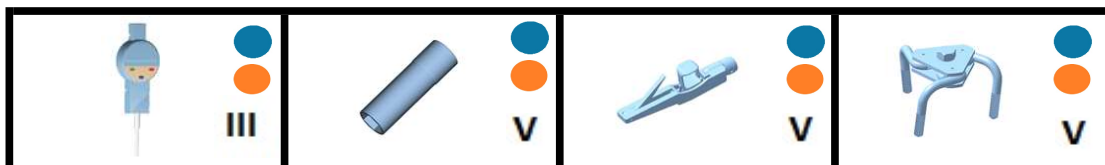













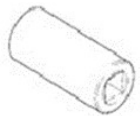

2992084	2992136	1899078	1899094
Slide Hammer Union	Sealing Disc Extraction Device	Socket double-hex AF 10 mm	Socket Flat Slot (Valve Lash)



1899409	1899047	1899062	1899142
Digital Dial Indicator	Socket AF 15 mm	V Belt Tensioner	Special Wrench

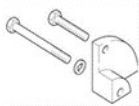

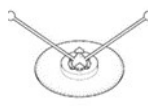











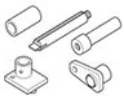
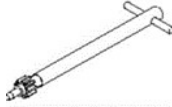

Legacy Special Tool List 914, 2011 & 2012

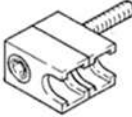
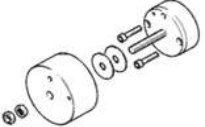
 <p style="text-align: right;">V</p>	 <p style="text-align: right;">V</p>	 <p style="text-align: right;">IV</p>	 <p style="text-align: right;">IV</p>
<p>2992068 Torque Angle Indicator</p>	<p>2992077 Manometer Crankcase Pressure</p>	<p>1899122 Special Bit IPR 30/70</p>	<p>1899124 Special Bit IPR 30/25</p>
 <p style="text-align: right;">I</p>	 <p style="text-align: right;">IV</p>	 <p style="text-align: right;">IV</p>	 <p style="text-align: right;">II</p>
<p>2992052 Fuel Delivery Time Indicator</p>	<p>2992060 Pointer use with 2992052</p>	<p>2992089 Injector Holder</p>	<p>1899052 Pliers Insert</p>
 <p style="text-align: right;">III</p>	 <p style="text-align: right;">III</p>	 <p style="text-align: right;">II</p>	 <p style="text-align: right;">I</p>
<p>1899060 E14 Hex Deep (Cylinder Head)</p>	<p>1899064 Injector Pump Socket</p>	<p>1899091 Micrometer Depth Gauge</p>	<p>1899181 Injector Pump Tester</p>
 <p style="text-align: right;">II</p>	 <p style="text-align: right;">II</p>	 <p style="text-align: right;">II</p>	 <p style="text-align: right;">II</p>
<p>2992012 Compression Tester Connector</p>	<p>2992036 Rig Pin</p>	<p>2992037 Crank & Cam Pins</p>	<p>2992038 Control Rod Locking Pin</p>
 <p style="text-align: right;">III</p>	 <p style="text-align: right;">III</p>	 <p style="text-align: right;">III</p>	 <p style="text-align: right;">III</p>
<p>2992045 Control Rod Measuring Device</p>	<p>2992047 Control Rod Locking Device</p>	<p>2992057 Graduated Disc</p>	<p>2992058 Graduated Disc Adapter</p>

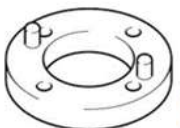
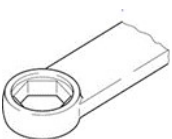

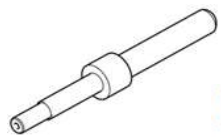
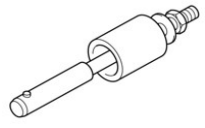
Legacy Special Tool List 914, 2011 & 2012

			
2992059 Injector Pump Retainer Pin	2992061 Socket 24mm	2992062 AF- Dial Indicator Holder	2992063 Dial Indicator Extension
			
2992087 Puller Union Joint	2992092 Control Rod Bushing Tool	2992098 Governor Setting Tool	2992103 Injector Drive wheel Press
			
2992108 Aux Sleeve for 2992103	2992109 Control Rod Bushing Installer	2992150 Spring Tensioner	2992193 Crankshaft Seal Flywheel Side
			
2992231 Flywheel Puller	2992236 Intermediate Disc Use with 2992483	2992258 Camshaft Pulley Hex Wrench	2992273 Two Jaw Puller
			
2992284 Oil Tube Installer	2992283 Oil Tube Extractor	2992330 Oil Pressure Sensor Tool 24 mm	2992464 Engine Turning Gear



Legacy Special Tool List 914, 2011 & 2012

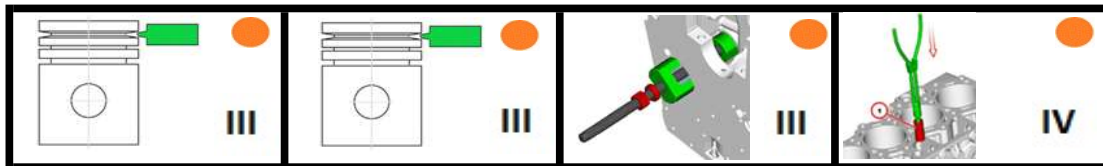

2992166	2992165	2992251	2992349
Ring Groove Wear (98 mm Piston)	Ring Groove Wear (101mm Piston)	Camshaft Bearing Tool	Special Pliers (Tappet Remover)

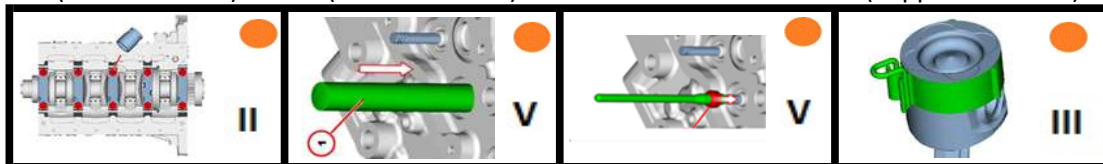

1899054	2992145	1899187	2992181
Socket 22 mm	Valve Stem Seal Installer	Valve stem Seal Tool (Three Piece Set)	Piston Ring Comp. (101MM)

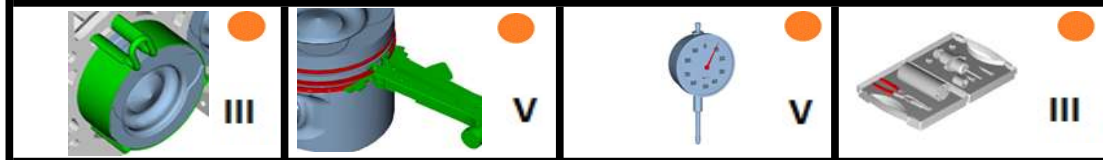

2992180	2992155	1899126	2992079
Piston Ring Compressor (98MM)	Piston Ring Expander	Dial Indicator	Base Circle Measuring Device





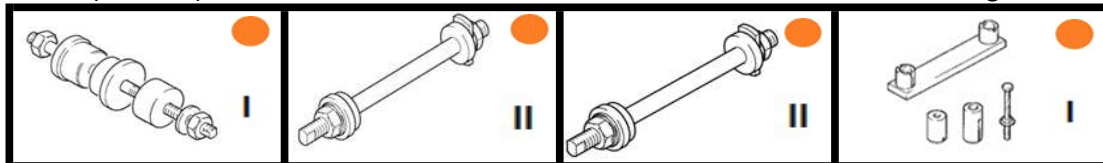

2992157	2992175	2992177	2992186
Ring Groove Wear (102MM)	Ring Compressor 102 MM	Ring Compressor 94 MM	Wrist Pin Lock Ring Inst.



2992241	2992245	2992249	2992296
Camshaft Bearing Installer	Camshaft Bearing Remover	Camshaft Bearing Remover	Piston Cooling Nozzel Alignment Tool

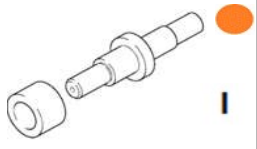
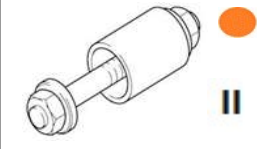
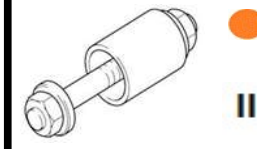

Legacy Special Tool List 914, 2011 & 2012

 I	 II	 II	 II
2992332 Bearing Installer / Remover	2992363 Connecting Rod Bushing 26 mm	2992364 Connecting Rod Bushing 30 mm	2992367 Camshaft Seal Installer
 I	 I		
2992368 Crankshaft Seal Installer	2992468 Cylinder Head Bolt Socket		